



Modbus/RS-485



913/914MB Multi-Channel Analog Input Modules

DC Current, DC Voltage or AC Current Input

Limit Alarms or Discrete Outputs

Models

913MB: 4 current input channels
914MB: 4 voltage input channels

Input Ranges

0 to 20mA DC,
±10V DC,
0 to 20A AC (with 5020-350 sensor)

Output

Four output channels:
Open-drain MOSFETs (1A DC loads)
0 to 35V DC

Network Communication

Modbus-RTU high-speed RS-485

Power Requirement

10 to 36V DC,
24V AC

Approvals

CE marked. UL, cUL listed
Class I; Division 2; Groups A, B, C, D.

DC Current/Voltage Input Module

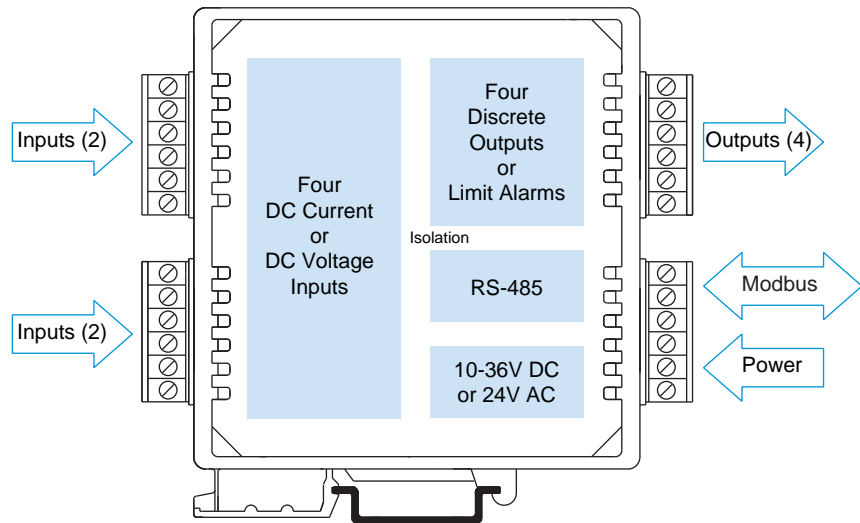

Description

This signal conditioner is a four-channel analog input module with four discrete outputs. It provides isolation between input, output, power, and network circuits. Network communication adheres to the industry-standard RS-485 Modbus RTU protocol. AC and DC power sources are supported with nonpolarized, diode-coupled terminals.

The inputs accommodate wide DC voltage or current ranges. Flexible discrete outputs operate as alarms or on/off controllers. As limit alarms, each discrete output can be configured with high and/or low setpoints exclusively tied to an analog input channel. Alarm trips function without host communication enabling low-cost stand-alone alarms, as well as local backup for the primary control system. Otherwise, on/off control is based on commands issued by the host system.

Combining flexible transmitter functions, mixed signal I/O, alarm support, and a network interface in a single package, makes this instrument extremely powerful. Multi-channel design adds cost-efficiency and allows high-density mounting. Plus, safe, rugged construction makes these modules reliable for use in both control room and distributed field I/O applications. Custom module configurations are also possible (consult factory for details).

Special Features

- Standard Modbus RTU protocol with high-speed RS-485 communication (up to 115K bps)
- 16-bit sigma-delta A/D yields 0.1% of range resolution and accuracy
- Four inputs in a single inch-wide module reduces system costs and saves panel space
- Four discrete outputs enable local limit alarms or host-controlled on/off switching
- Heavy-duty 1A solid-state relays provide dependable on/off control of industrial devices
- Self-calibration lowers maintenance costs by reducing periodic manual calibration checks
- Watchdog timers provide a configurable failsafe output state for use when host I/O communication is lost
- Four-way isolation eliminates potential ground loops between power, input, output, and network circuitry
- Self-diagnostics monitor microcontroller activity to detect operational failures (lock-up) and execute a reset to restore communication

AC Current Sensor Model 5020-350



For 913MB. Order separately (one per channel).



Performance Specifications

General Input

Resolution
0.005% or 1 part in 20,000.

Noise Rejection
Normal mode: 40dB @ 60Hz, typical.
Common mode: 140dB @ 60Hz, typical.

Input Filter Bandwidth
-3dB at 3Hz, typical.

Input Conversion Rate
180ms per channel.

Current Input (913MB)

DC Current Input Ranges
Range user-configured. Range selected applies to all channels.

0 to 1mA, 0 to 20mA, 4 to 20mA,
0 to 11.17mA (for use with 5020-350 AC sensor).

DC Current Input Resistance
49.9 ohms.

DC Current Input Accuracy
±0.1% of input range.

Voltage Input (914MB)

DC Voltage Input Ranges
Range user-configured. Range selected applies to all channels.

±10V, ±5V, ±2.5V, ±1.25V,
±625mV, ±313mV, ±156mV, ±78mV

Input Impedance
110.5K ohms.

DC Voltage Input Accuracy
±0.1% of input range.

Discrete Output

Output Type
Four independent open drain MOSFET switches with a common return that operate as low-side switches.

Output Voltage Range
0 to 35V DC.
External voltage source required.

Output Current Range
0 to 1A DC continuous for each output.

Output OFF Leakage Current
50µA maximum.

Output ON Resistance
0.15 ohms maximum.

Output Response Time
4.1ms typical, from receipt of command to gate transition of the output MOSFET.

Operation
Digital outputs are set to their OFF state following a software or power-on reset. Outputs can optionally be set to user-defined states following a watchdog timeout. Watchdog timeout output control takes precedence over limit alarm control. Alarm control takes precedence over host control.

Communication

Supported Modbus Commands
The command/response protocol for communicating with this module adheres to the Modbus/RTU standard for the following Modbus Functions.

- Read Coil (Output) Status
- Read Holding Registers
- Read Input Registers
- Force Single Coil (Output)
- Preset Single Register
- Force Multiple Coils (Output)
- Preset Multiple Registers
- Report Slave ID
- Reset Slave

LED Indicators

LEDs indicate power, status, and discrete level/alarm.

Power and Isolation

Power Requirements
10 to 36V DC or 22 to 26V AC.

Supply Current

Supply	Current Draw
10V DC	125mA maximum
24V DC	50mA maximum
24V AC	100mA rms maximum

Isolation

1500V AC for 60 seconds or 250V AC continuous. 4-way isolation between input, network, power, and discrete I/O circuits. Inputs are isolated channel-to-channel for common mode voltage to ±4V DC.

Ordering Information

Models

913MB-0900

914MB-0900

DC current (913MB) or voltage (914MB) input module

Accessories

900C-SIP

Configuration Software Interface Package (includes software CD-ROM for Windows, RS-232/485 converter, and RS-485/three-wire cable)

5020-350

AC current sensor for 913MB. One for each channel

TBK-B02

Optional terminal block kit, barrier strip style, 4 pcs.

TBK-S02

Optional terminal block kit, spring clamp style, 4 pcs.

PS5R-VB24

Power supply (24V DC, 2.1A)

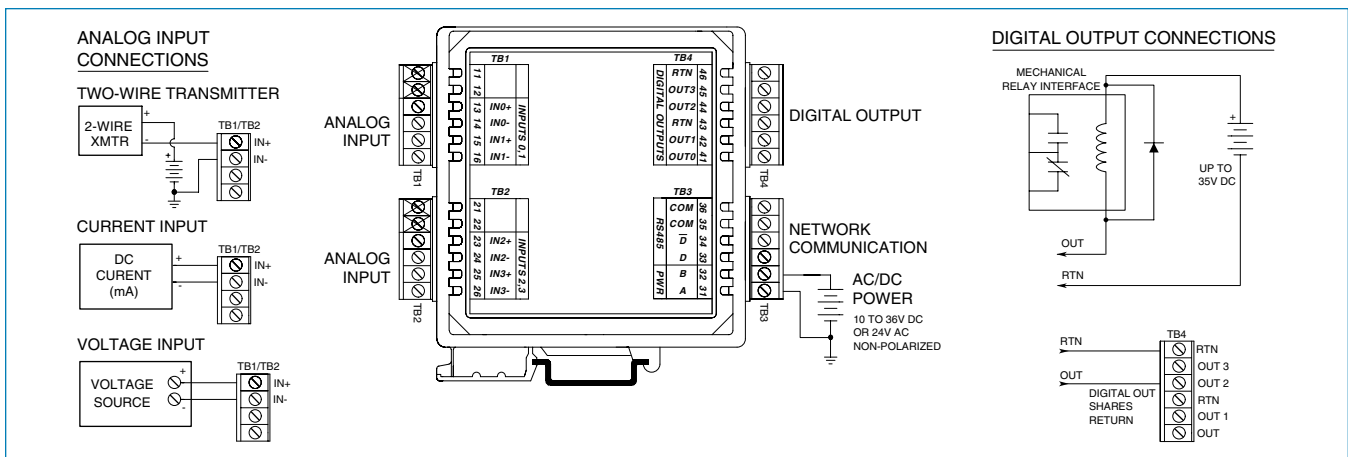



900MB Series Technical Diagrams

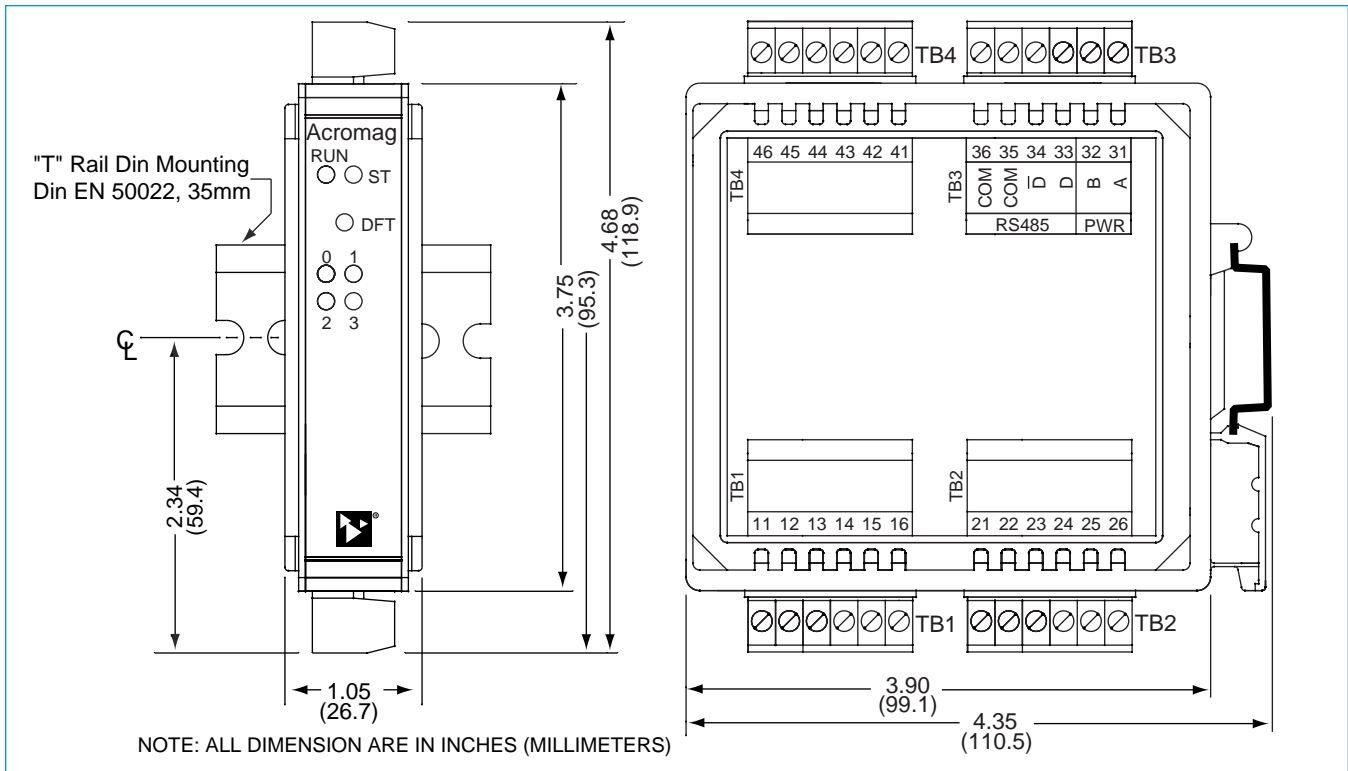

PERSONAL COMPUTER
W/ WINDOWS 95/98 OR NT

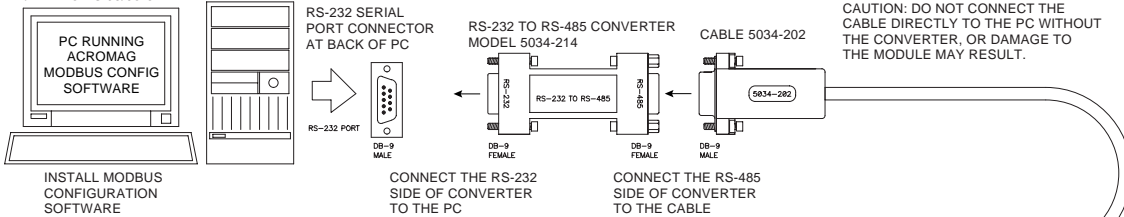

900C-SIP COMMUNICATION CONNECTIONS

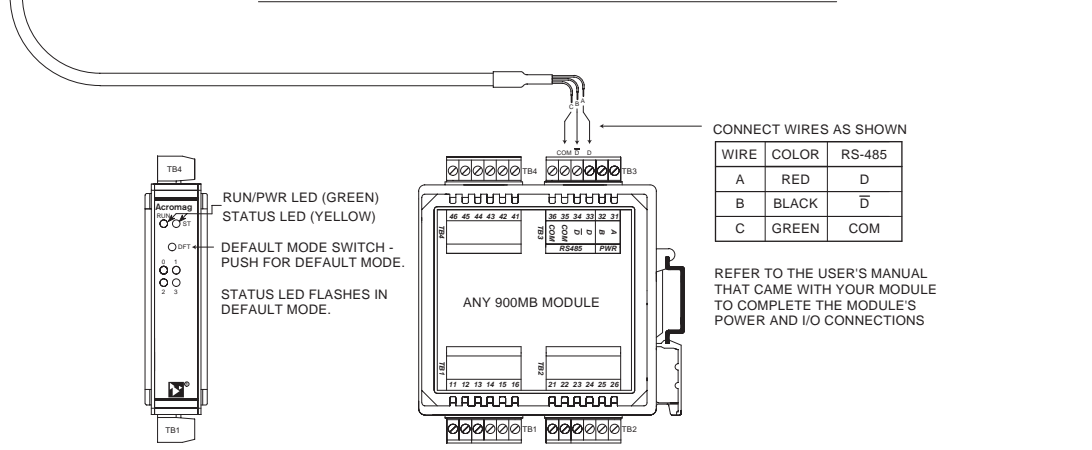



Performance

Discrete Inputs (901 & 903 models only)

Input Type

12 active-low, buffered inputs, with a common connection. Inputs include transient suppression devices and series connected 100K ohm resistors, plus diode over-voltage clamps to the internal +5V supply.

Input Signal Voltage Range

0 to 35V DC, maximum.

Input Current

293µA, typical at 35V DC.

Input Signal Threshold

TTL compatible with 100mV of hysteresis, typical. Low-to-High threshold is 1.7VDC, High-to-Low is 1.6VDC, typical. Limited to TTL levels of 0.8VDC (max. LOW level) and 2.0VDC (min. HIGH level).

Input Resistance

100K ohms, typical.

Input Hysteresis

100mV DC, typical.

Discrete Outputs (902 & 903 models only)

Output Type

12 independent, open-drain, DMOS MOSFET switches with a common source connection that operate as low-side switches.

Output Voltage Range

0 to 35V DC max. (0 to 500mA/channel continuous). External voltage source required.

Output ON Resistance

0.28 ohms maximum.

Output Response Time

Force Single Coil: Output updates within 250µs of receipt of a command.

Force Multiple Coils: First coil updates in 250µs, followed successively by additional coils every 180µs.

General

I/O Pull-ups and Socket

5.6K ohm pull-up resistor SIPs are installed in sockets at each port (four-channels per port).

Excitation (per port)

External excitation voltage for each four-channel port is limited to 35V or less.

Supported Modbus Commands

The command/response protocol for communicating with this module adheres to the Modbus/RTU standard for the following Modbus Functions.

- Read Coil (Output) Status
- Read Input Status
- Read Holding Registers
- Force Single Coil (Output)
- Preset Single Register
- Reset Slave
- Force Multiple Coils (Outputs)
- Preset Multiple Registers
- Report Slave ID

LED Indicators

LEDs indicate power, status, and discrete level.

Power Requirements

10 to 36V DC,
22 to 26V AC.

Supply Current

Supply	Current Draw
10V DC	130mA maximum
24V DC	54mA maximum
24V AC	95mA maximum

Isolation

1500V AC for 60 seconds or 250V AC continuous. 3-way isolation between I/O, network, and power circuits.

Ordering Information

Models

901MB-0900
Discrete input module

902MB-0900
Discrete output module

903MB-0900
Discrete input/output module

Accessories

900C-SIP

Configuration Software Interface Package (includes software CD-ROM for Windows, RS-232/485 converter, and RS-485/three-wire cable)

4001-095

USB-to-RS232 adapter

TBK-B02

Optional terminal block kit, barrier strip style, 4 pcs.

TBK-S02

Optional terminal block kit, spring clamp style, 4 pcs.

PSSR-VB24

Power supply (24V DC, 2.1A)

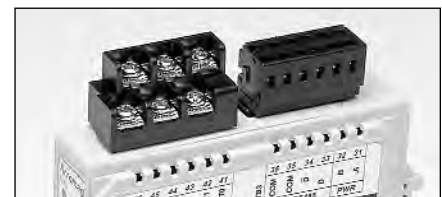

Optional terminal blocks: barrier strip (left) and spring clamp (right). Cage clamp terminal is standard.

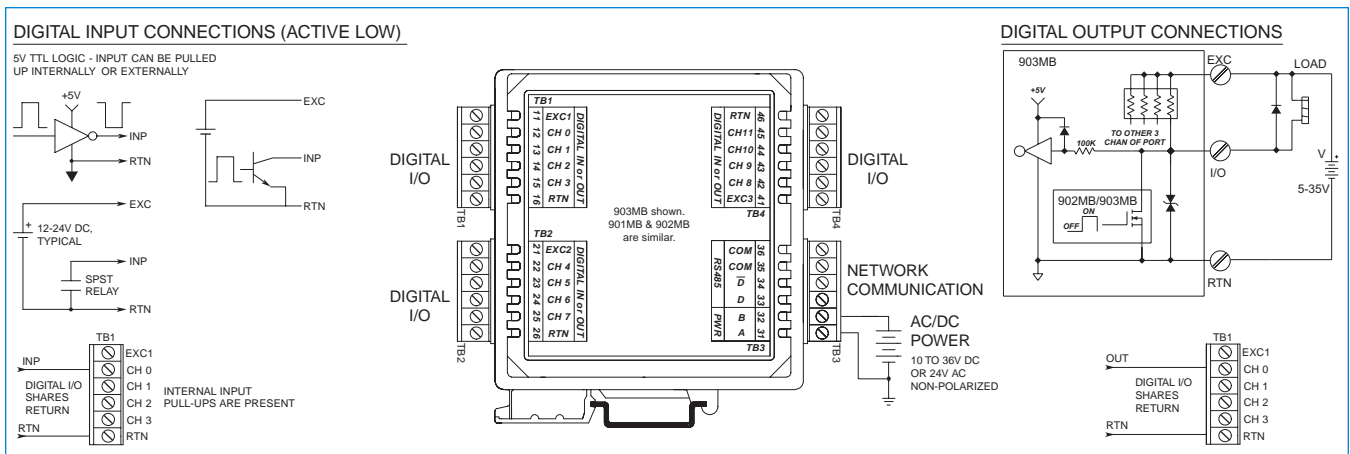

BusWorks® Modbus I/O

Model 4001-095 USB-to-Serial Adapter

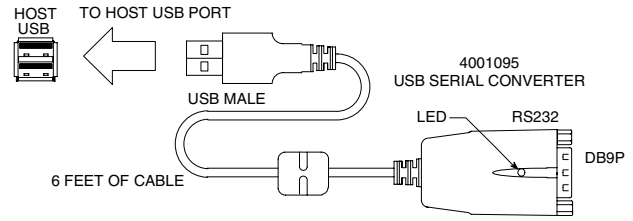
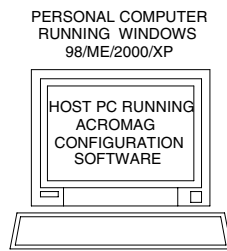
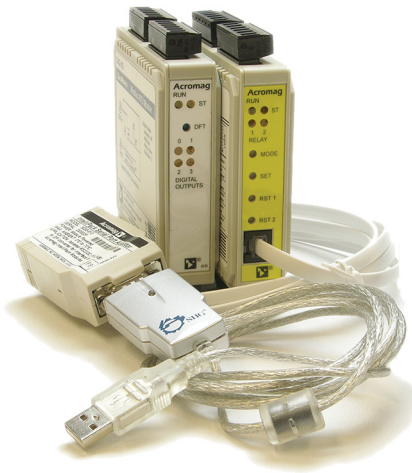

Simplifies configuration of Acromag I/O Modules ♦ Enables configuration via USB port

Description

This device is a USB-to-serial adapter that you can use to communicate with many Acromag I/O products for setup and re-configuration for your application.

Key Features & Benefits

- Connects to I/O modules via USB (other adapters may be necessary)
- Complete RS232 control signals
- Conforms to USB Specification, Version 1.1
- USB-powered
- Cable length, 6 ft., UL approved

Performance Specifications

USB Specification
Version 1.1

Data rate
Up to 115.2Kbps

Environmental Standards
RoHS-compliant

Basic Power Consumption
150mA

PC Requirements
Windows® 7 and newer.

Ordering Information

NOTE: For more information visit www.acromag.com.

Adapters

- [4001-095](#)
USB to serial adapter. Includes driver CD and manual.
- [5030-913](#)
Serial port adapter. DB9S connector to RJ11 jack.
- [5034-202](#)
RS-485 to 3-wire cable converter and cable, DB-9M to 3 x 12AWG RS-485 cable, 8 ft.
- [5032-787](#)
RS-232 to 151T transmitter configuration device converter and cable, 6 ft.
- [5034-214](#)
Non-isolated RS-232 to RS-485 Serial Port Converter, DB-9F to DB-9F.

Cables

- [5030-902](#)
Cable. 6 feet long with RJ11 plug at each end.

IntelliPack 800x Series Adapter and Cable

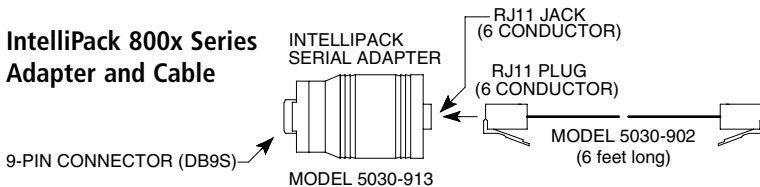

900MB Modbus Series Adapter and Cable

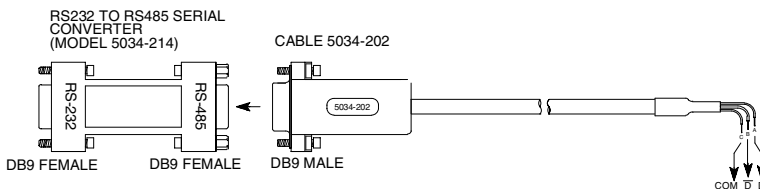

Tel: 248-295-0880 ■ sales@acromag.com ■ www.acromag.com ■ 30765 S Wixom Rd, Wixom, MI 48393 USA