

外形寸法図

RC2900-16C1-AU1

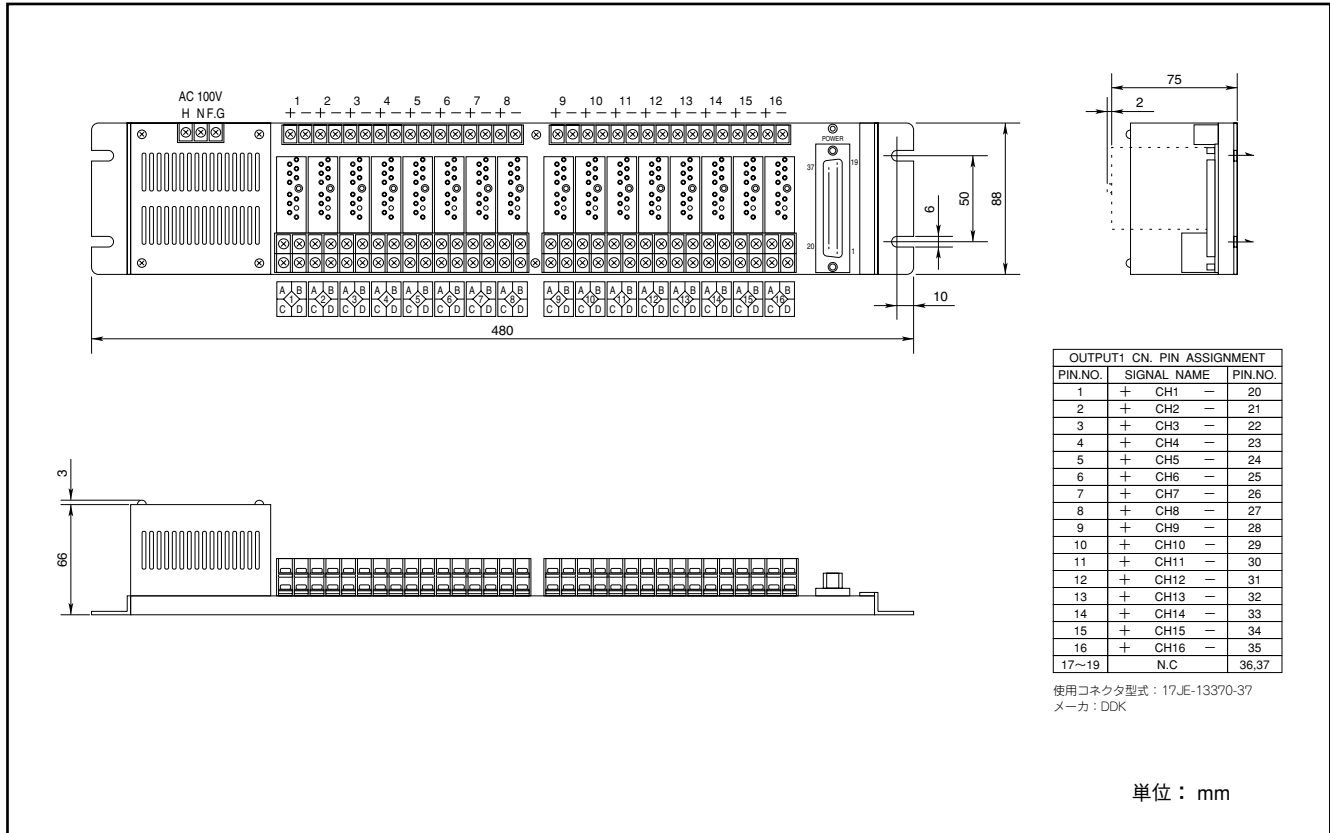

RC2900-16C1-D1

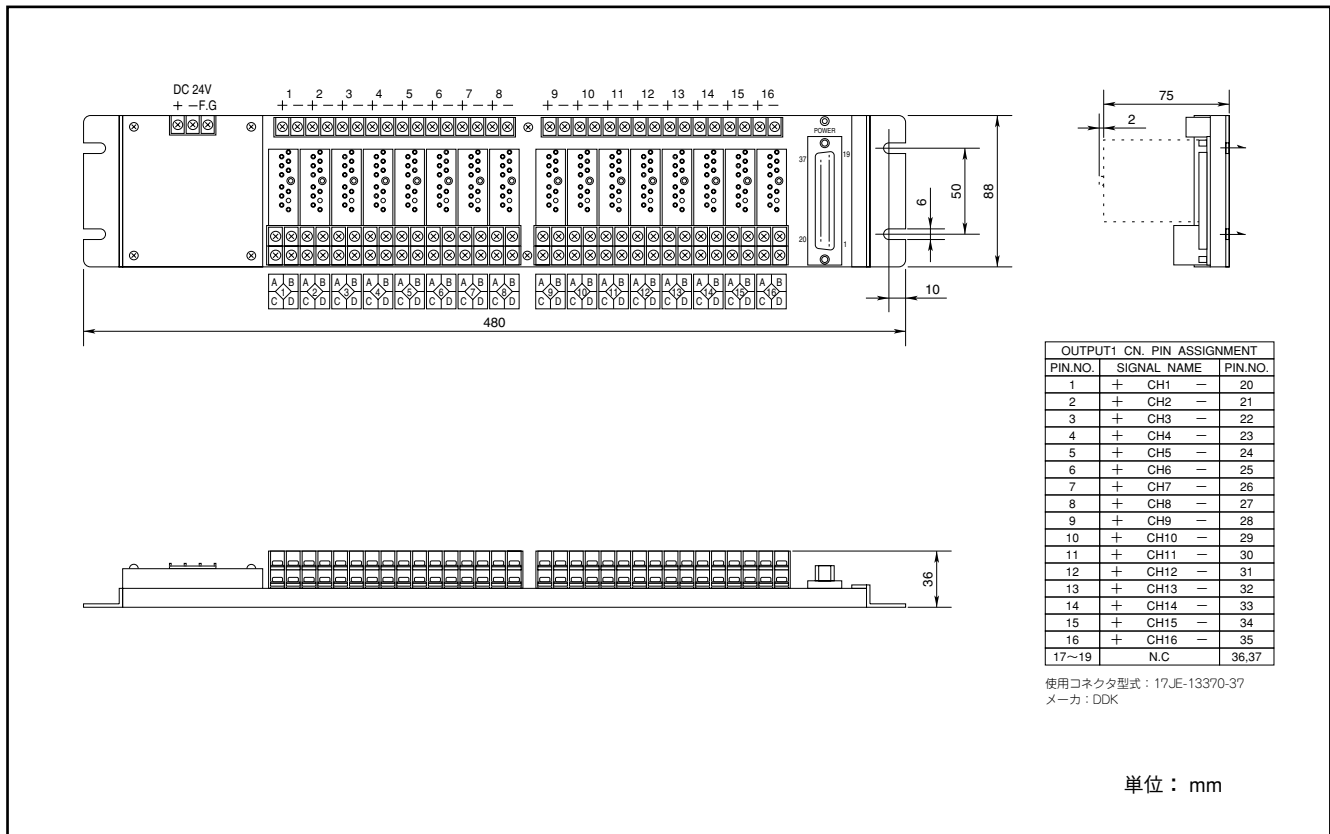

外形寸法图

RC2900-16TB-AU1

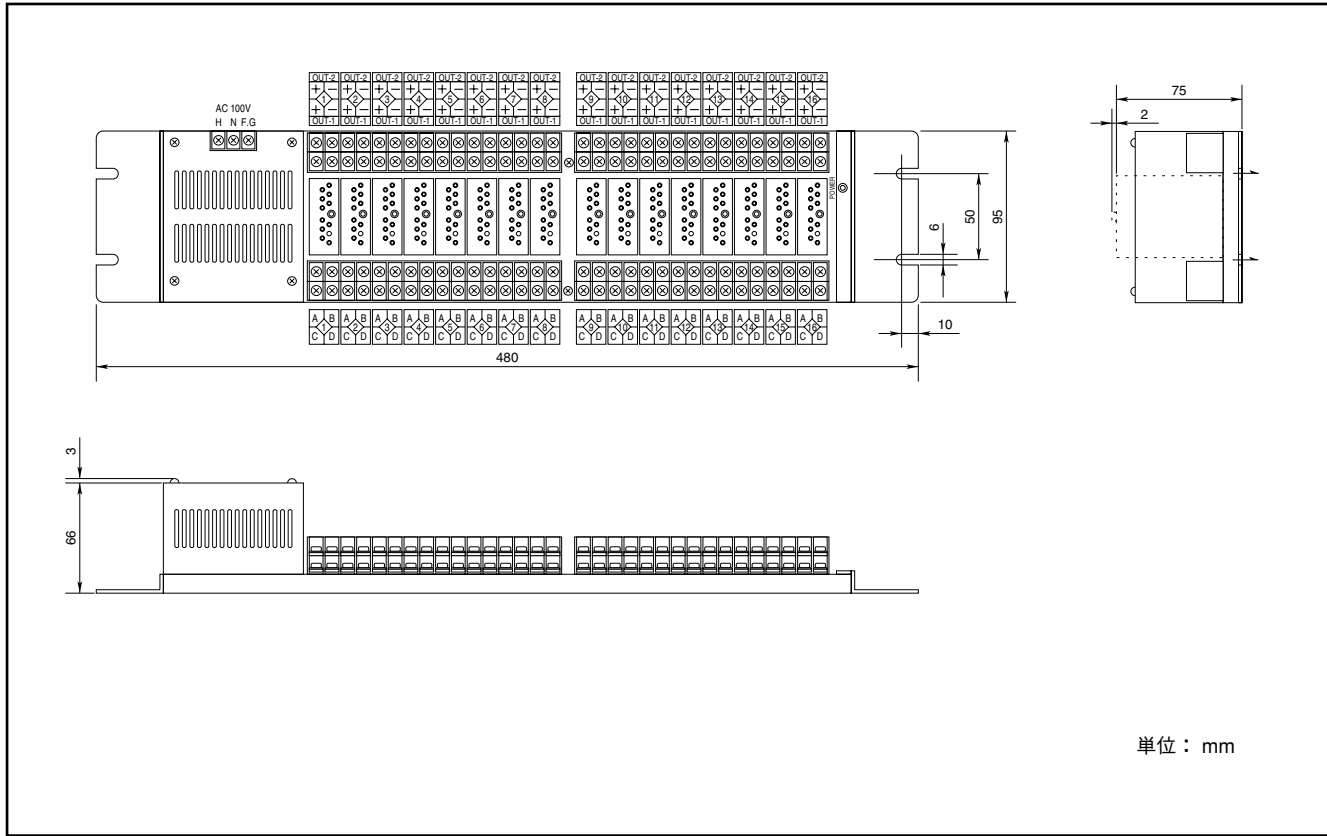

RC-2900-16TB-D1

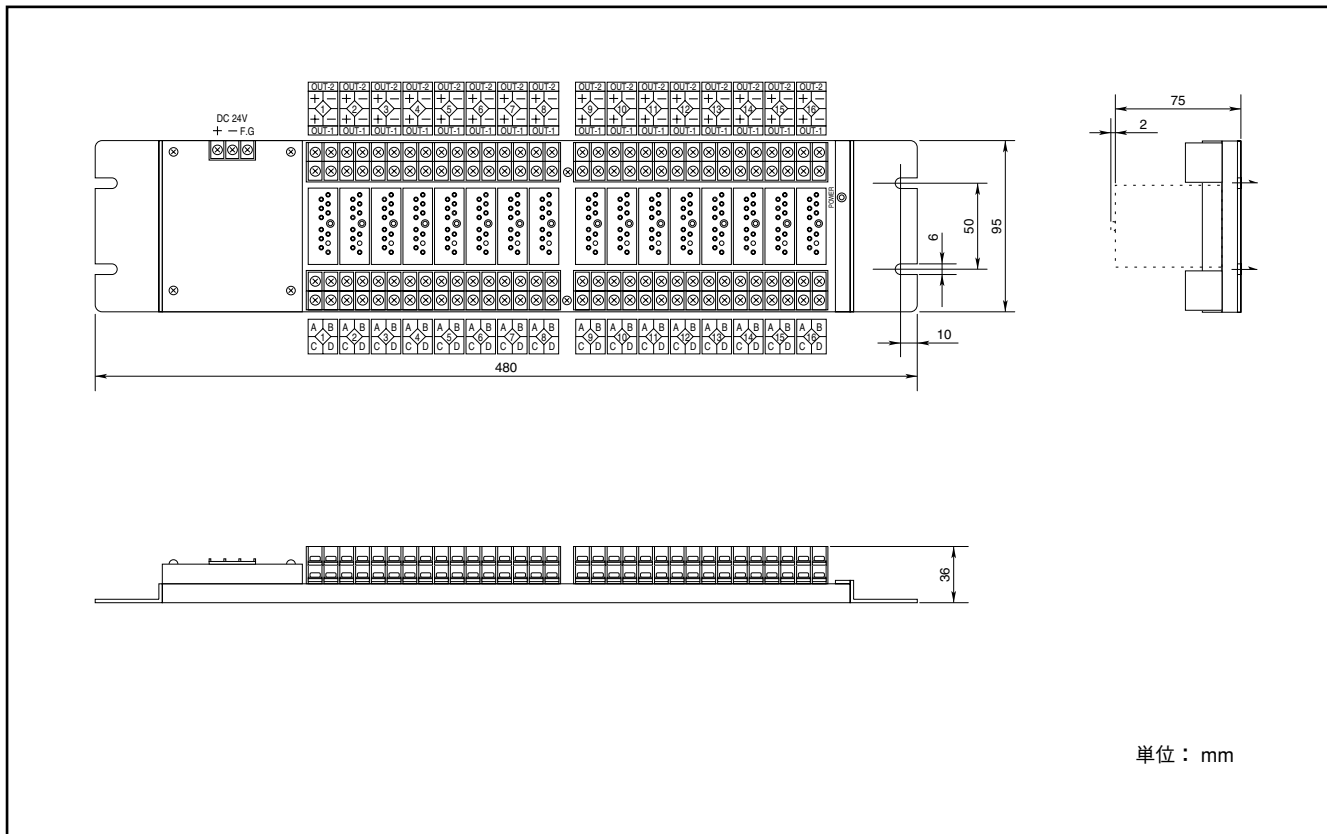

外形寸法図

RC2900-08C1-AU1

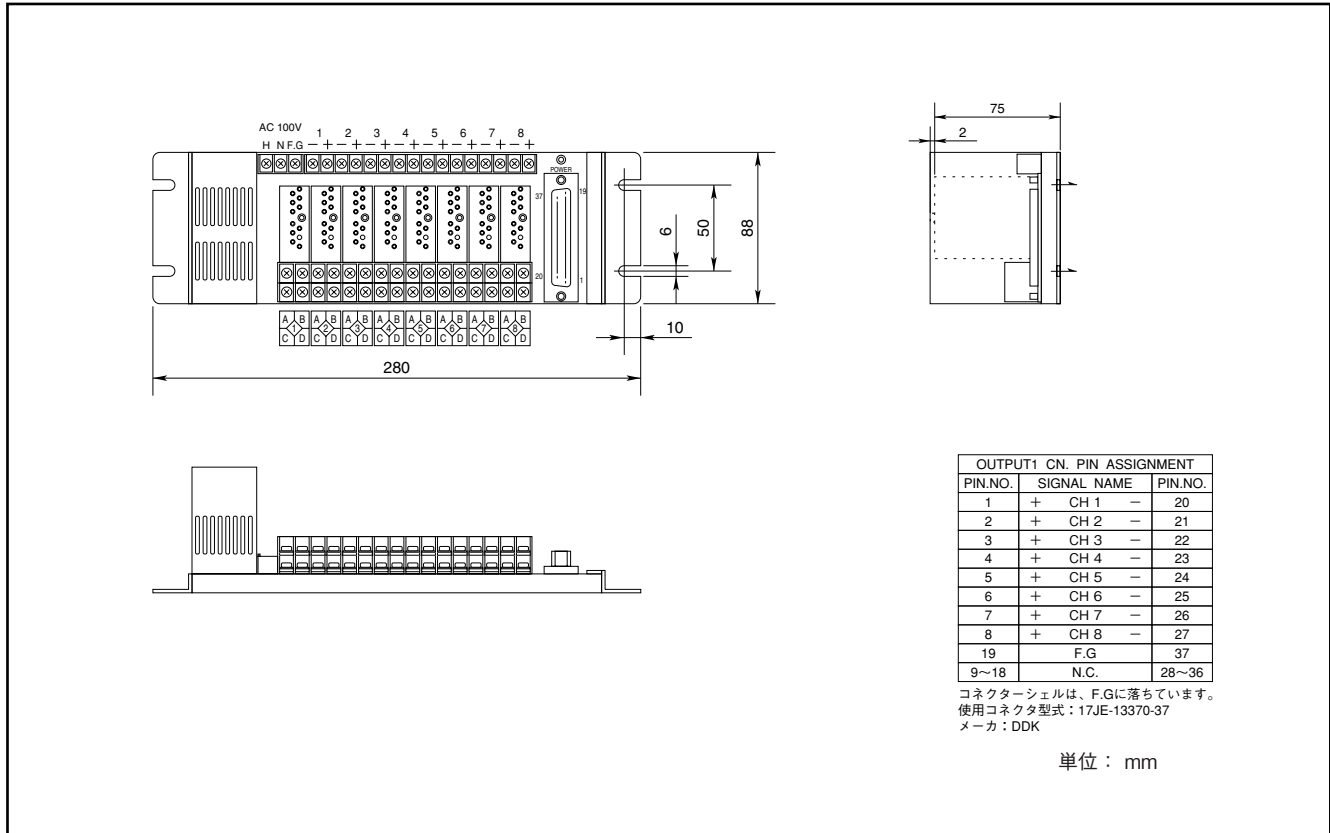

RC2900-08C1-D1

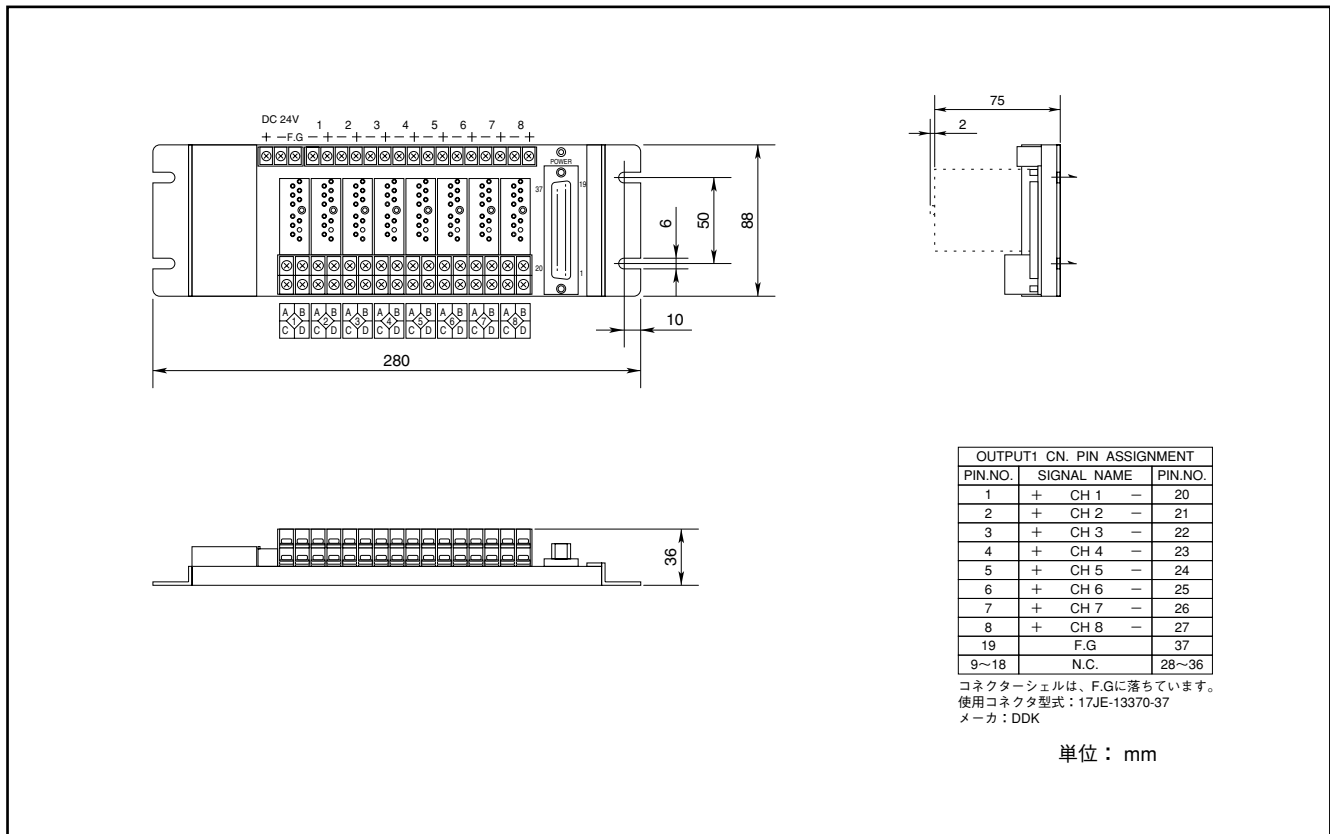

外形寸法图

RC2900-08TB-AU1

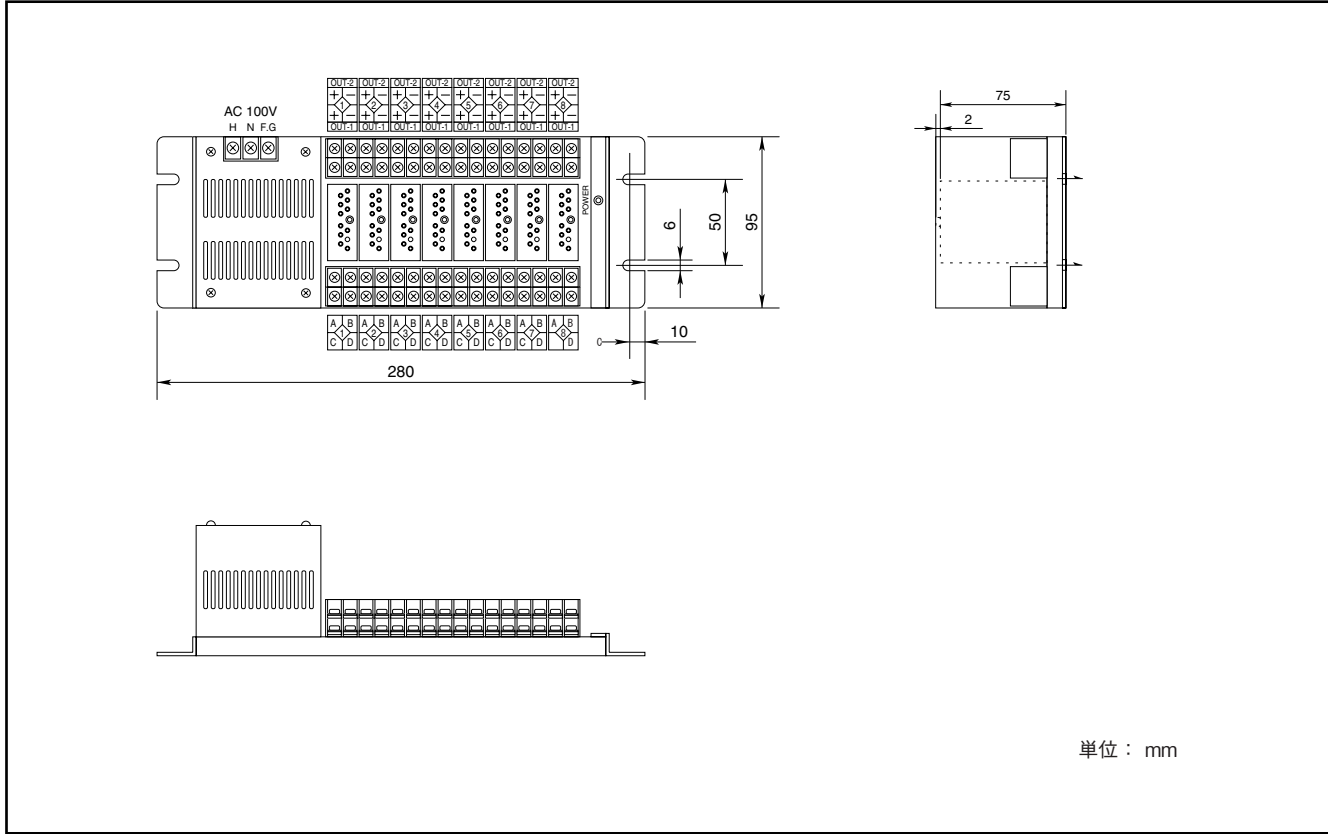

RC2900-08TB-D1

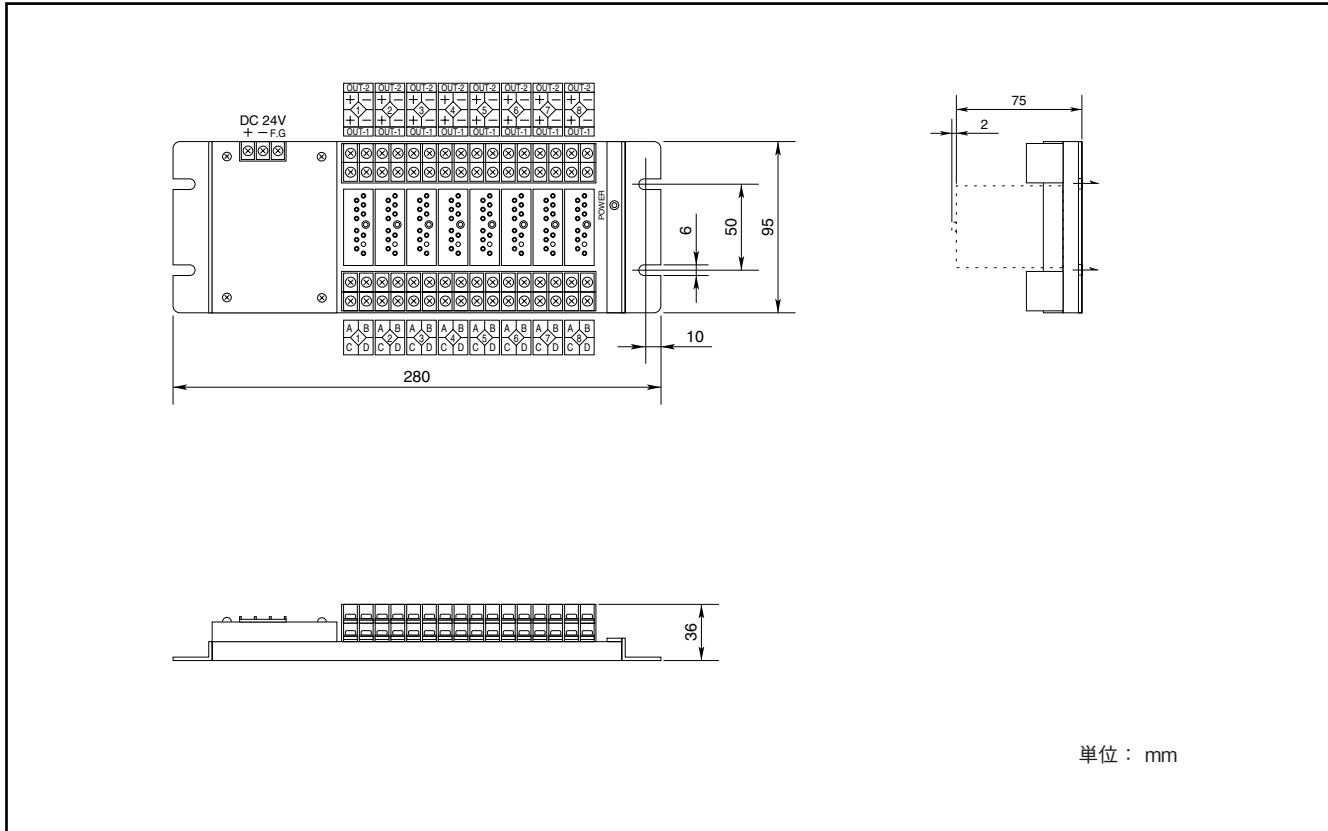

外形寸法図

RC2900-04TB-AU

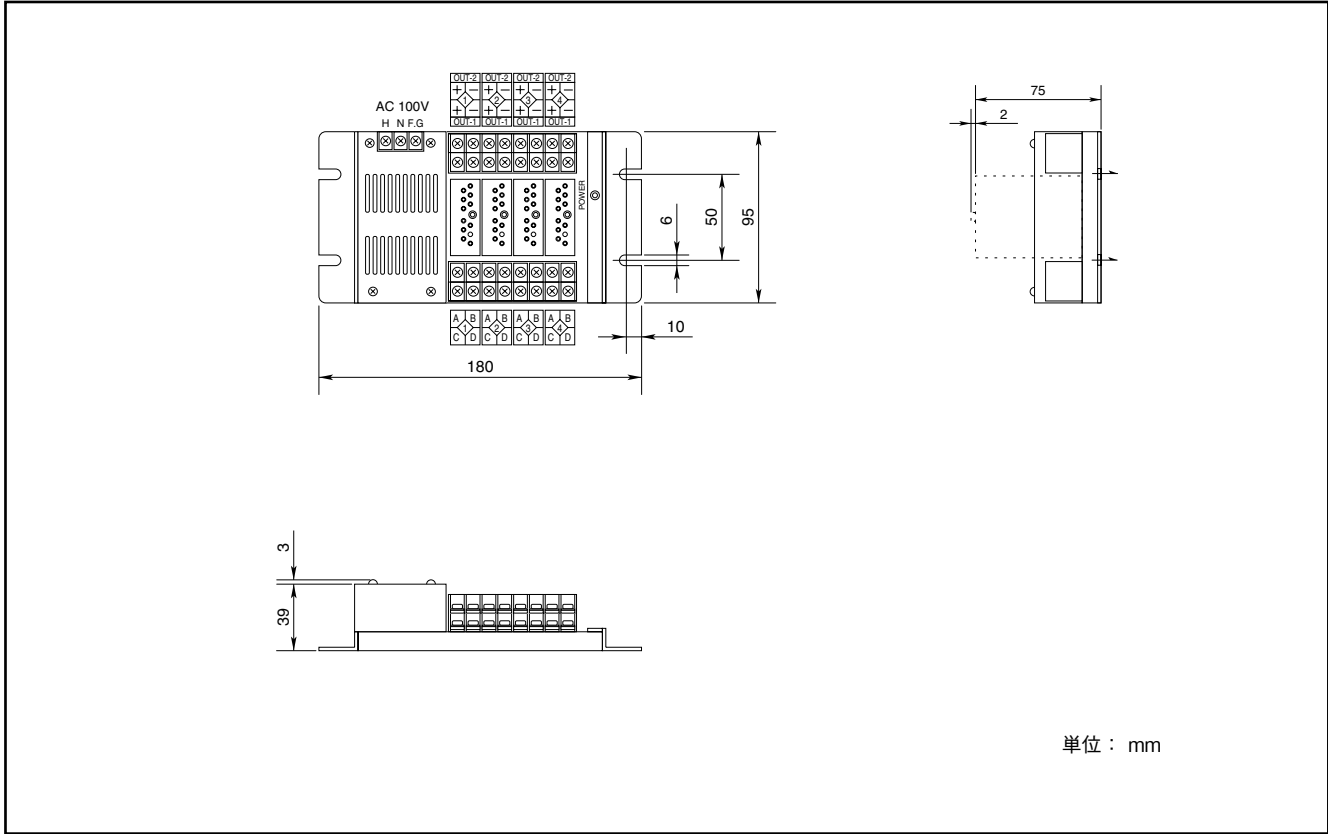

RC2900-04TB-D1

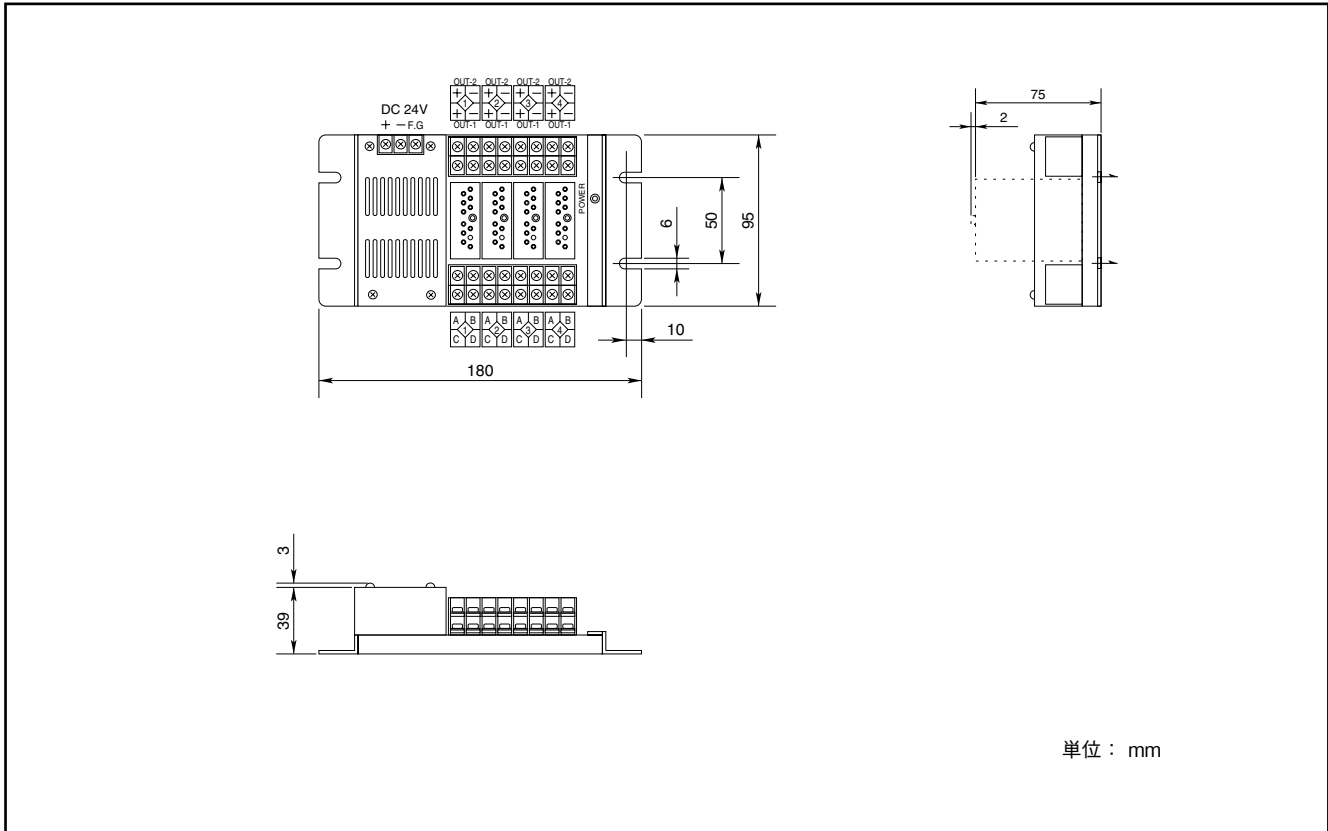

外形寸法図

BP2900

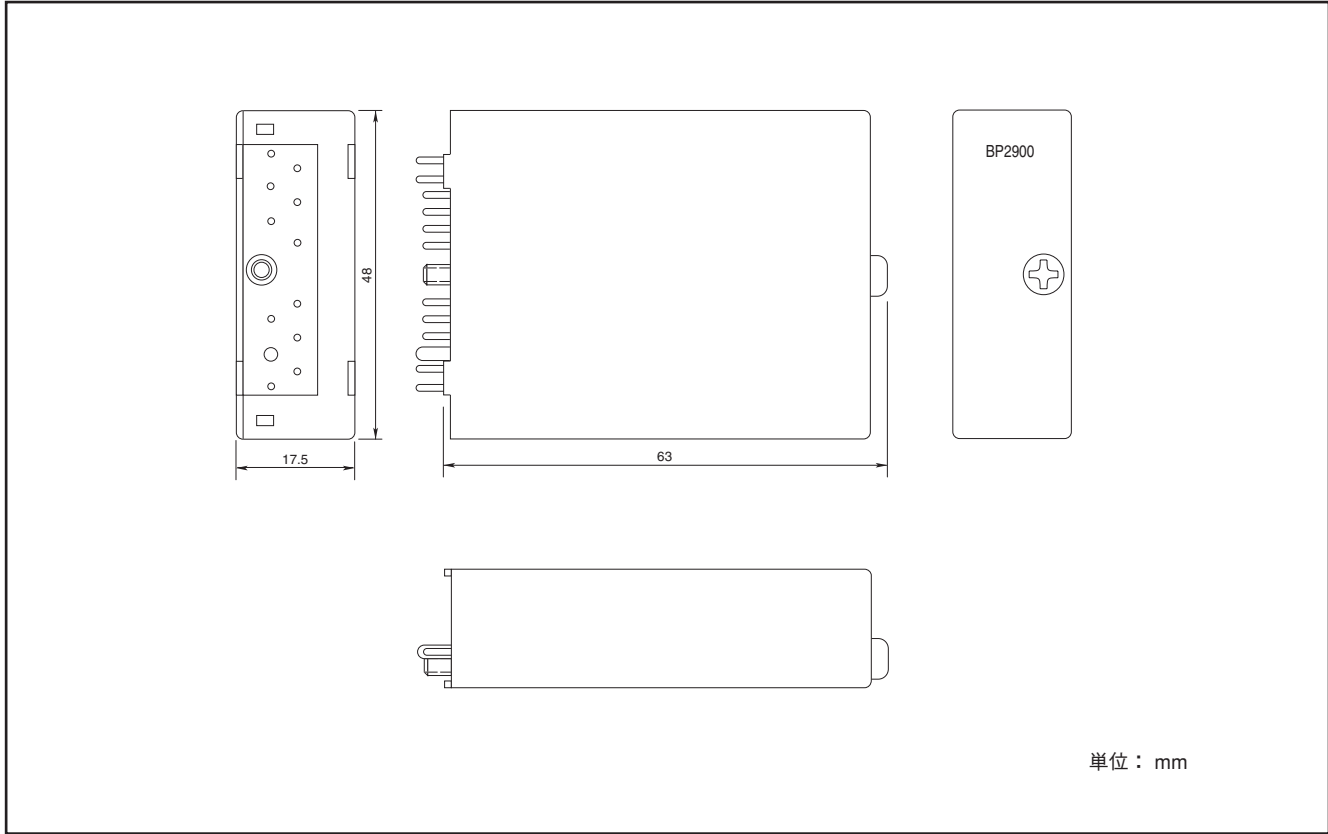

単位：mm

RC2900-01TB-D1

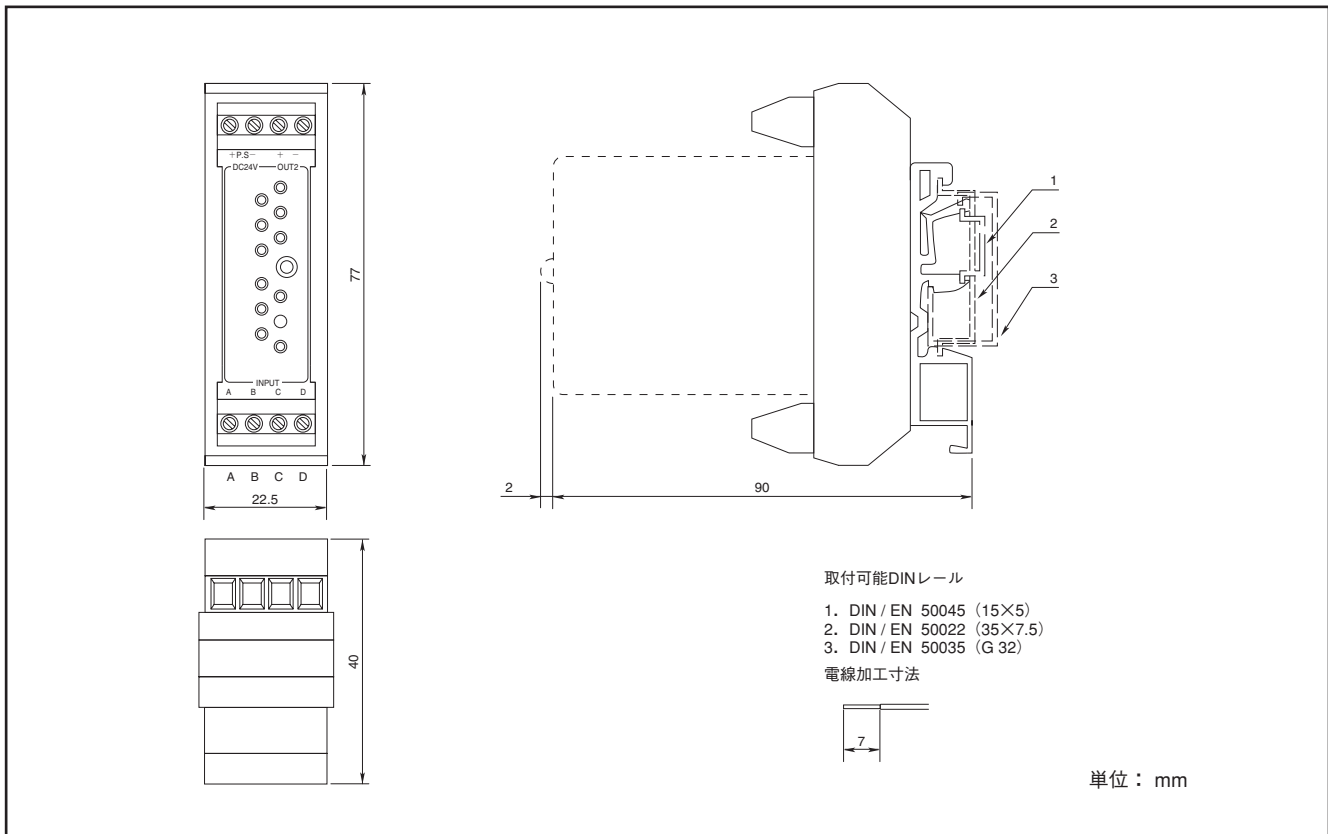

外形寸法図

RS2900-D-01TB-D1/A1

TERMINAL BLOCK PIN ASSIGNMENT

ピン番号	7	8	9	10	5	6	3	4
MS2901	+TC	-TC	C.J	C.J	+OUT-1	-	+OUT-2	-
MS2902	A	B	B'	N.C.	+OUT-1	-	+OUT-2	-
MS2903	+ IN	-	N.C.	N.C.	+OUT-1	-	+OUT-2	-
MS2904	+ IN	-	N.C.	N.C.	+OUT-1	-	+OUT-2	-
MS2905	+ IN	-	N.C.	N.C.	+OUT-1	-	+OUT-2	-
MS2906	IN+	IN-	EX+	EX-	+OUT-1	-	+OUT-2	-
MS2907	+ IN	-	COM	N.C.	+OUT-1	-	+OUT-2	-
MS2907A	+ IN	-	COM	N.C.	+OUT-1	-	+OUT-2	-
MS2908	+ IN	-	N.C.	N.C.	+OUT-1	-	+OUT-2	-
MS2909	+ IN	-	N.C.	N.C.	+OUT-1	-	+OUT-2	-
MS2910	A	B	C	N.C.	+OUT-1	-	+OUT-2	-
MS2916	+ IN	-	N.C.	N.C.	+OUT-1	-	+OUT-2	-
MS2920	L	CL	N	L SIG. N	+OUT-1	-	+OUT-2	-
MS2921	N.C.	N.C.	L	PT N	+OUT-1	-	+OUT-2	-
MS2937	+ IN	-	N.C.	N.C.	+OUT-1	-	+OUT-2	-
MS2954	+ OUT	-	N.C.	N.C.	+ IN	-	N.C.	N.C.
MS2900-TH	+ IN	-	N.C.	N.C.	+OUT-1	-	+OUT-2	-

-D1

1	+	POWER SUPPLY DC24V
2	-	

-A1

1	H	POWER SUPPLY AC100V
2	N	

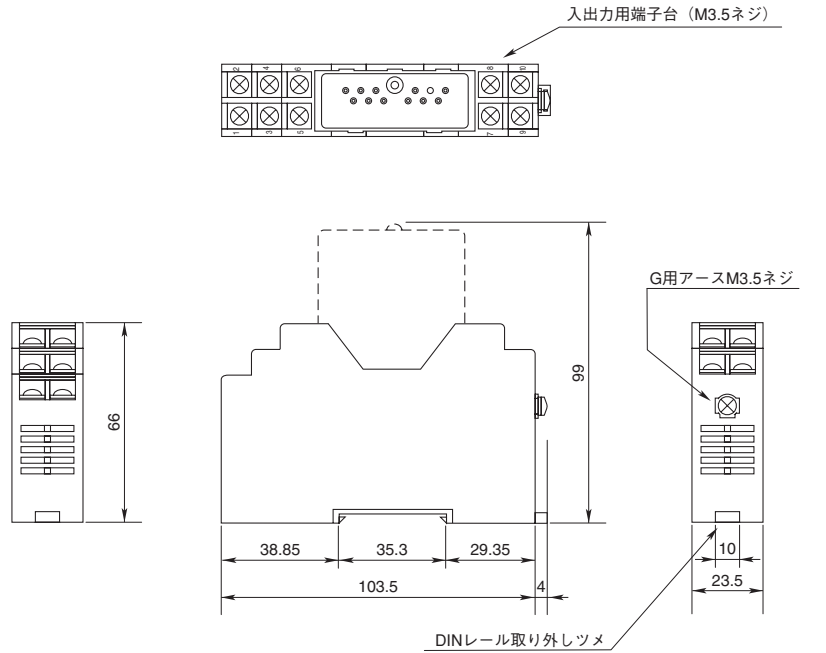

単位：mm

RS2900-R-01TB-D1/A1

TERMINAL BLOCK PIN ASSIGNMENT

ピン番号	7	8	9	10	5	6	3	4
MS2901	+TC	-TC	C.J	C.J	+OUT-1	-	+OUT-2	-
MS2902	A	B	B'	N.C.	+OUT-1	-	+OUT-2	-
MS2903	+ IN	-	N.C.	N.C.	+OUT-1	-	+OUT-2	-
MS2904	+ IN	-	N.C.	N.C.	+OUT-1	-	+OUT-2	-
MS2905	+ IN	-	N.C.	N.C.	+OUT-1	-	+OUT-2	-
MS2906	IN+	IN-	EX+	EX-	+OUT-1	-	+OUT-2	-
MS2907	+ IN	-	COM	N.C.	+OUT-1	-	+OUT-2	-
MS2907A	+ IN	-	COM	N.C.	+OUT-1	-	+OUT-2	-
MS2908	+ IN	-	N.C.	N.C.	+OUT-1	-	+OUT-2	-
MS2909	+ IN	-	N.C.	N.C.	+OUT-1	-	+OUT-2	-
MS2910	A	B	C	N.C.	+OUT-1	-	+OUT-2	-
MS2916	+ IN	-	N.C.	N.C.	+OUT-1	-	+OUT-2	-
MS2920	L	CL	N	L SIG. N	+OUT-1	-	+OUT-2	-
MS2921	N.C.	N.C.	L	PT N	+OUT-1	-	+OUT-2	-
MS2937	+ IN	-	N.C.	N.C.	+OUT-1	-	+OUT-2	-
MS2954	+ OUT	-	N.C.	N.C.	+ IN	-	N.C.	N.C.
MS2900-TH	+ IN	-	N.C.	N.C.	+OUT-1	-	+OUT-2	-

-D1

1	+	POWER SUPPLY DC24V
2	-	

-A1

1	H	POWER SUPPLY AC100V
2	N	

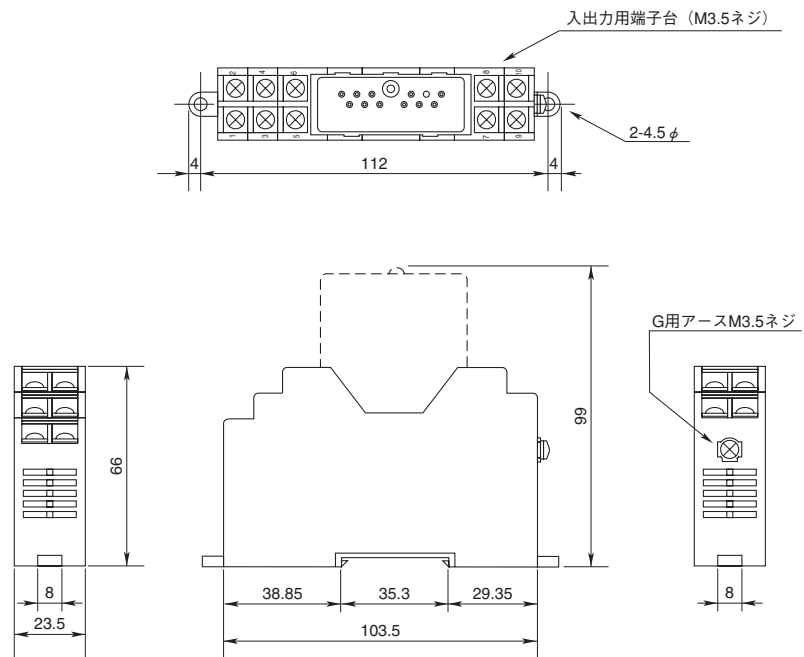

単位：mm